

营销员	
发图时间	
交样时间	

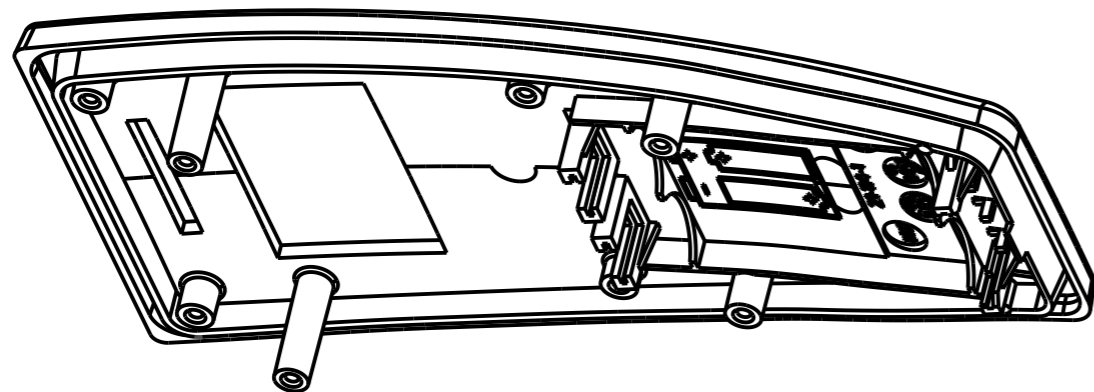
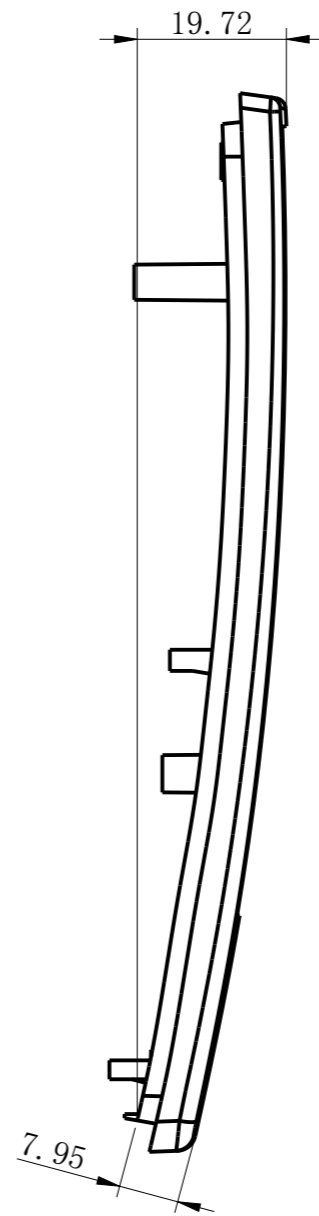
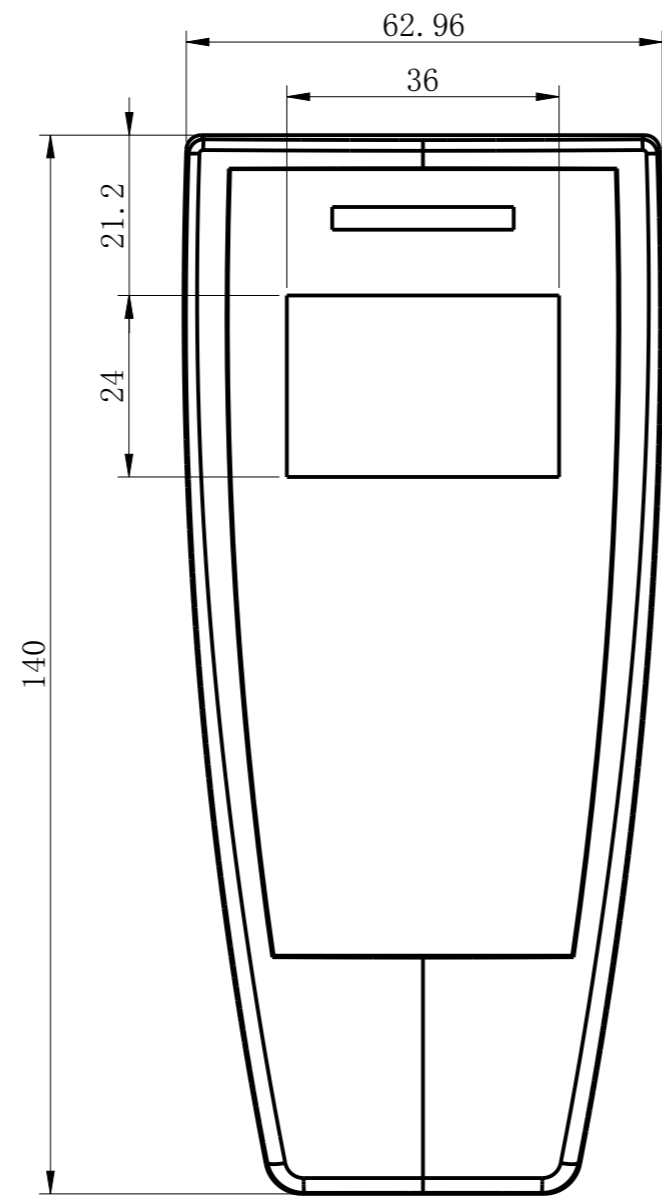

制图 Drawing	审核 Audiling	批准 Confirm	客户名称 Custom Name	材料 Material	ABS
			产品名称 Product Name	图纸比例 Drawing Scale	A3
			产品编号 Product Code	视图 Project View	(mm)
共 页 第 页			宁波三和壳体公司 NINGBO SANHE ENCLOSURE CORPORATION		中国宁波慈溪 TEL: 864574163226910 FAX: 864574163226900